

## Heater CONDENS

For condensing boilers and heat pumps

- ECOenergy – energy-saving fans, modulation system
- Modern design
- Effective heating in the range of 5 - 120kW
- Remote control by mobile application

Available  
with  
EC fan



**55** countries  
with our brand

 TOP  
quality

 best price and  
customer service

# Heatercondens

Available with EC fan

more at [sonniger.com](http://sonniger.com)



manual



model 3D

TECHNICAL PARAMETERS		HEATER CONDENS						
		CR ONE	CR1	CR2	CR3	CR2MAX	CR3 MAX	CR4 MAX
index AC		WA0015	WA0016	WA0017	WA0018	WA0024	WA0025	WA0026
index EC		WA0015EC	WA0016EC	WA0017EC	WA0018EC	WA0024EC	WA0025EC	WA0026EC
suggested heat output range*	kW	5-25	10-35	15-50	20-70	25-70	35-95	40-120
heat output (70/50°C) / ΔT air temperature increase**	kW/°C	13 kW / 25°C	16 kW / 13°C	26 kW / 22°C	35 kW / 34°C	40 kW / 22°C	53 kW / 35°C	68 kW / 44°C
number of unit rows		2	1	2	3	2	3	3
air output - III speed	m3/h	1600	3900	3350	2950	5700	5600	5100
sound level at 5m distance - III speed	dB	52	62	60	60	59	58	58
diameter of connection nozzles	"	1/2	3/4	3/4	3/4	3/4	3/4	3/4
power supply parameters AC fan V/Hz 230/50	W/A	124/0,58	250/1,08	250/1,08	250/1,08	520/2,2	520/2,2	520/2,2
power supply parameters EC fan V/Hz 230/50	W/A	127/0,59	250/1,09	250/1,09	250/1,09	520/2,29	520/2,29	520/2,29

\* presented heat output for water agent temperature range 50/30°C - 120/90°C, air inlet temperature 0°C, III speed  
 \*\* for air inlet temperature 0°C

## Unit sizes

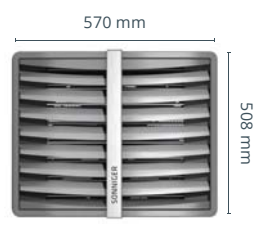

CR ONE

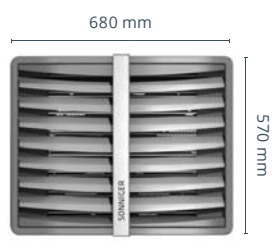

CR1 | CR2 | CR3

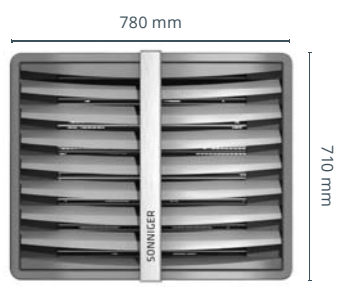

CR2 MAX | CR3 MAX | CR4 MAX

## Destratifier MIX



installation height:  
 MIX 1 up to 13 m, MIX 2 up to 16 m

## Accessories



- Panel COMFORT (WAA0054N)**
- Unique SONNIGER design
  - Manual speed regulation
  - Ventilation in the summer season
  - for AC units



- Panel INTELLIGENT Wi-Fi (WAA0035W/EC)**
- Control units from mobile app
  - Automatic change of fan speed
  - Compatible with BMS-MODBUS
  - for AC and EC units

## Remote control

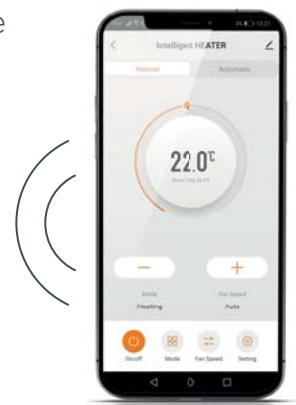

Multiple units connection  
**MULTI 6 AC (WAA0055)**  
**MULTI 10 EC (WAA0126)**



## Installation

Wall installation

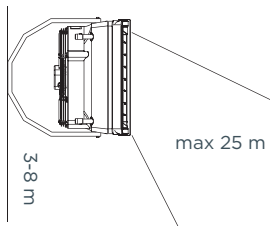

Ceiling installation

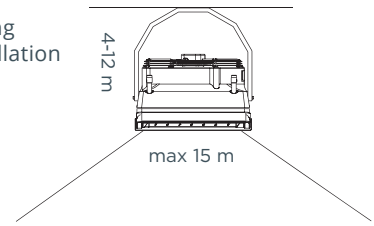

For condensing boilers and heat pumps



energy-saving fans, modulation system



effective heating 5 - 120 kW



remote control using mobile app



BEST PRICE

## Destratifier Mix Improves heat comfort

- ECOenergy - heat loss reduction
- Effective range up to 16 m
- Wide working area up to 450 m<sup>2</sup>
- Simple installation



TECHNICAL PARAMETERS	HEATER MIX	
	MIX 1	MIX 2
index AC	WA0022	WA0027
index EC	WA0022EC	WA0027EC
max. air output	m <sup>3</sup> /h 4800	7200
installation height	m 6-13	9-16
working area	m <sup>2</sup> 200-380	300-450
power supply parameters AC fan V/Hz 230/50	W/A 250/1,08	520/2,2
power supply parameters EC fan V/Hz 230/50	W/A 250/1,09	520/2,29
rotation speed	rpm 1350	1380
fan IP	IP54	IP54
sound level	dB 54	49
weight	kg 9,2	15,8

### Installation

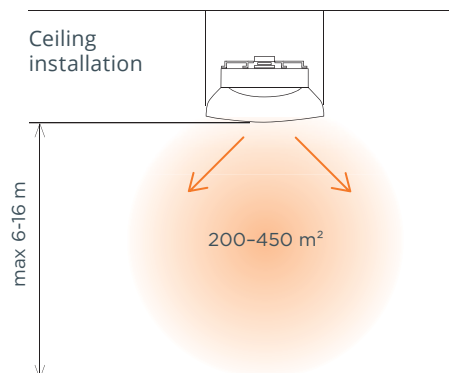

### One of the most popular destratifiers

- Destratifiers are devices that eliminate the effects of convection by mixing air masses and thus equalizing the temperature gradient
- Reduce heat loss through the roof, and at the same time reduce energy consumption for heating

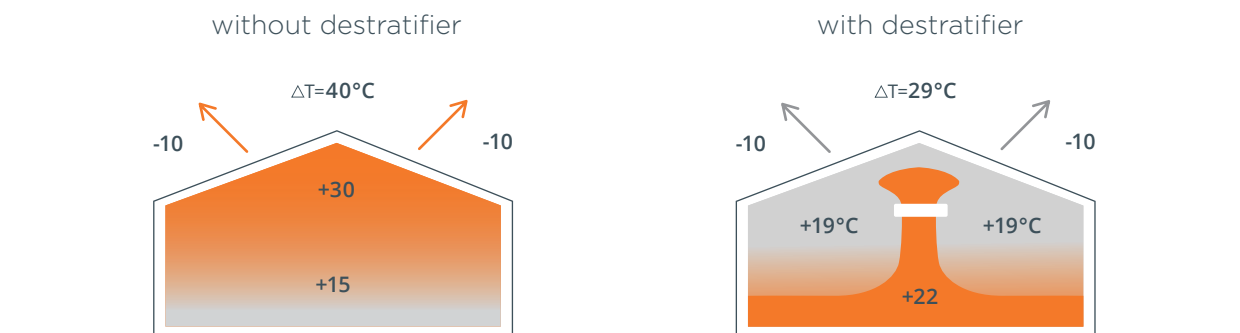

## GUARD air curtain

### Leader in energy loss protection

- ECOenergy – energy-saving PTC heater
- Modern design
- Effective protection - quiet operation
- Remote control by mobile application



**55** countries  
with our brand

**Q** TOP  
quality

**\$** best price  
Sufficient support

# Guard

more at  
[sonniger.com](http://sonniger.com)



manual



model 3D

TECHNICAL PARAMETERS	AIR CURTAINS WITH WATER HEATER			AIR CURTAINS WITH ELECTRIC HEATER			AIR CURTAINS WITHOUT HEATER			
	GUARD 100W	GUARD 150W	GUARD 200W	GUARD 100E	GUARD 150E	GUARD 200E	GUARD 100C	GUARD 150C	GUARD 200C	
index	CG0019	CG0020	CG0021	CG0022	CG0023	CG0024	CG0025	CG0026	CG0027	
unit length	m	1	1,5	2	1	1,5	2	1	1,5	2
effective range	m	4	4	4	4	4	4	4	4	4
heat output range	kW	10-16	20-29	25-40	4 - 7	6,5 - 11	8,5 - 14	-	-	-
max. air output	m <sup>3</sup> /h	2000	3600	4800	2000	3600	4800	2100	3700	5000
diameter of connection nozzles	"	1/2	1/2	1/2	-	-	-	-	-	-
supply voltage	V/Hz A	230/50 1,4 A	230/50 1,8 A	230/50 2,4 A	3x400/50 14 A	3x400/50 21 A	3x400/50 27,5 A	230/50 1,4 A	230/50 1,8 A	230/50 2,4 A

## ACCESSORIES

Magnetic door switch | **DOOR SWITCH (CGA0028)**

Remote control



### Panel COMFORT (WAA0054N)

- Unique SONNIGER design
- Manual speed regulation
- Switch-off heating element in the summer season



### Panel INTELLIGENT Wi-Fi (WAA0035W)

- Remote control using mobile app
- Manual speed regulation
- Compatible with BMS-MODBUS



## HORIZONTAL AIR FLOW RANGE (max range for horizontal installation)

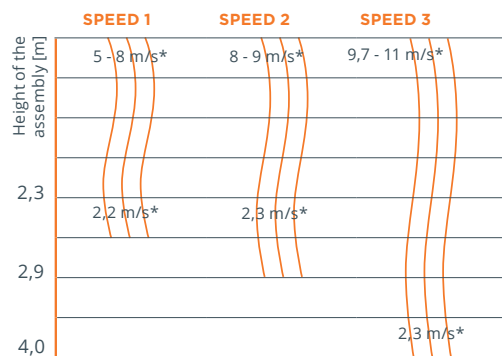

## VERTICAL AIR FLOW RANGE (max range for vertical installation)

\* air flow speed

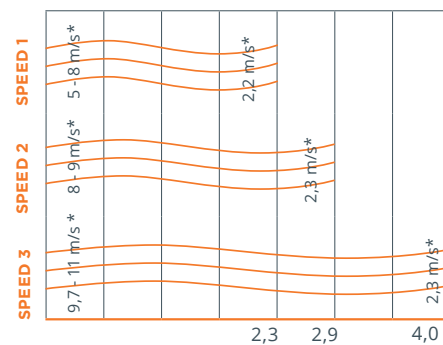

## Unit length



ECOenergy PTC heater



modern design



effective protection - quiet operation



remote control using mobile app



BEST PRICE



## Guard Pro industrial air curtain Leader in energy loss protection

- ECOenergy - energy-saving fan, PTC electric heater
- Effective protection - range up to 9 m
- Modular assembly - vertical or horizontal
- Active Protection System



**55** countries  
with our brand

**Q** TOP  
quality

**\$** best price and  
customer support

# Guard Pro

Available with EC fan

more at [sonniger.com](http://sonniger.com)



manual



model 3D

TECHNICAL PARAMETERS	AIR CURTAINS WITH WATER HEATER		AIR CURTAINS WITH ELECTRIC HEATER		AIR CURTAINS WITHOUT HEATER	
	GUARD PRO 150W	GUARD PRO 200W	GUARD PRO 150E	GUARD PRO 200E	GUARD PRO 150C	GUARD PRO 200C
index AC	CGP0023	CGP0024	CGP0032	CGP0033	CGP0025	CGP0026
index EC	CGP0023EC	CGP0024EC	CGP0032EC	CGP0033EC	CGP0025EC	CGP0026EC
unit length	m 1,5	2	1,5	2	1,5	2
effective range	m 8	8	8	8	9	9
heat output range*	kW 33*	47*	14	21	-	-
max. air output	m <sup>3</sup> /h 6 500	9 100	6 550	9 450	6 700	9 600
diameter of connection nozzles	" 3/4"	3/4"	-	-	-	-
supply voltage	V/Hz A 230/50 2,16 A	230/50 3,24 A	3x400/50 23,5 A	3x400/50 30 A	230/50 2,16 A	230/50 3,24 A

\* maximum heat output indicated for 90/70°C water agent temperature and air inlet temperature 0°C.

## ACCESSORIES

Multiple units connection | **MULTI 6 (WAA0055)**

Possibility to connect a door switch | **DOORSTOP (CGPA0010)**



### Panel COMFORT (WAA0054N)

- Unique SONNIGER design
- Manual speed regulation
- Switch-off heating element in the summer season



### Panel INTELLIGENT Wi-Fi (WAA0035W)

- Control units from mobile device
- Switch-off heating element in the summer season
- Compatible with BMS-MODBUS

Remote control



## AIR FLOW RANGE



## Active Protection system

**Active Protection** system increases protection efficiency of the entrance gate by heating the lower part of the air barrier.

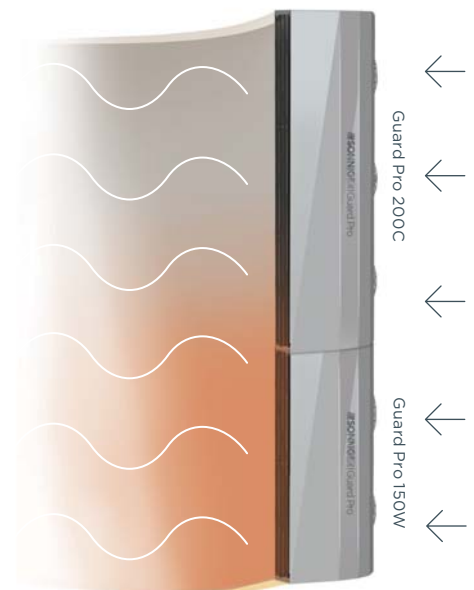

energy-efficient fans  
PTC electric heater



effective protection  
- range up to 9 m



horizontal or vertical  
modular installation



Active Protection  
system



**BEST PRICE**





References  
we deliver to 55 countries in the world



**SONNIGER S.A.**  
ul. Śląska 35/37, 81-310 Gdynia, Poland  
Phone: +48 801 889 855  
E-mail: [export@sonniger.com](mailto:export@sonniger.com)  
**WWW.SONNIGER.COM**

